

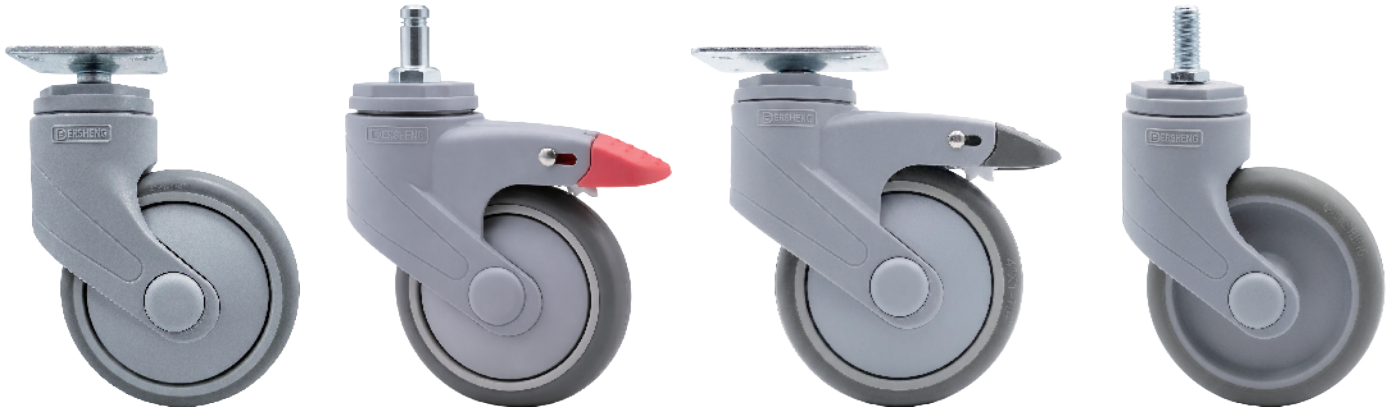

# 1155-2 Series STAT Series Caster (All Plastic)

- High grade synthetic housing  
Smooth and easy rolling, these casters noticeably reduce the effort to operate equipment  
Highly effective Thread guards prevent failure from strings and other debris.  
Specifically designed for healthcare and institutional applications where silence is essential.  
Corrosion resistant with non-marking wheels  
Directional lock also available



## » Features



Total Lock Brake



Directional Lock Brake



Long Pedal



Extra Long Pedal



Magnetic Free Caster

\*Images are for illustrative purposes only. Please refer to the actual product.

## » Wheel Options



Resolute



TPR on PP Core



TPR on PP Core (Dount)

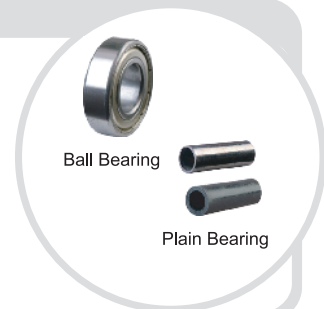

Ball Bearing

Plain Bearing

\*Images are for illustrative purposes only. Please refer to the actual product.



» TOP PLATE SIZE AND BOLT HOLE SPACING

Size	Top Plate Size	Bolt Hole Spacing	Attaching Bolt Size
3" 4"	42X42mm (1-21/32"x1-21/32")	32X32mm (1-1/4"x1-1/4")	M4/M5
	60X60mm (2-3/8"x2-3/8")	42.5X42.5mm (1-11/16"x1-11/16")	M6
	59X73mm (2-5/16"x2-7/8")	39.3X53mm (1-9/16"x2-1/16")	M6/M8
	62X94mm (2-7/16"x3-11/16")	45X75mm (1-3/4"x2-15/16")	M6/M8
	69X96mm (2-11/16"x3-3/4")	49X74.5mm (2-1/8"x3")	M8

» CYLINDRICAL STEM SPECIFICATION









Size	Diameter x Length	Hole Height	Bore Size
3" 4"	φ11 x 22L	—	Grip Ring
	φ12 x 25L	17 mm	6.3 mm

» THREADED STEM SPECIFICATION

Size	Threaded Size	Size	Threaded Size
3" 4"	M10X15mm	3" 4"	M12X15mm
	M10X20mm		M12X20mm
	M10X25mm		M12X25mm
	3/8-16UNC x 25 mm		1/2-12UNC x 25 mm

Diameter×Width	Specification	Load	Material	Item No.			Bearing	Overall Height	Offset	Swivel radius
				Swivel	Total Lock Brack	Directional Lock				
100mmx24mm (4"x15/16")	Plate	50kgs (110lbs)	TPR on PP Core	1155-0402-75-2	1155-0402-75-4	1155-0402-75-9	Ball Bearing	145.5mm	Swivel 36mm	Swivel 86mm Swivel W/Brake (Short pedal) 112mm Swivel W/Brake (Long pedal) 123mm Swivel W/Brake (Extra long pedal) 136mm
		50kgs (110lbs)	Resolute	1155-0402-68-2	1155-0402-68-4	1155-0402-68-9	Ball Bearing			
		50kgs (110lbs)	TPR on PP Core	1155-0402-75-2	1155-0402-75-4	1155-0402-75-9	Plain Bearing			
		50kgs (110lbs)	TPR on PP Core	1155-0402-75-2	1155-0402-75-4	1155-0402-75-9	Plain Bearing			
100mmx31mm (4"x1-1/4")		50kgs (110lbs)	TPR on PP Core	1155-0402-75-2	1155-0402-75-4	1155-0402-75-9	Ball Bearing			
		50kgs (110lbs)	Resolute	1155-0402-68-2	1155-0402-68-4	1155-0402-68-9	Ball Bearing			
		50kgs (110lbs)	TPR on PP Core	1155-0402-75-2	1155-0402-75-4	1155-0402-75-9	Plain Bearing			
		50kgs (110lbs)	TPR on PP Core	1155-0402-75-2	1155-0402-75-4	1155-0402-75-9	Plain Bearing			



 Diameter×Width	Specification	 Load	 Material	 Item No.			 Bearing	 Overall Height	 Offset	 Swivel radius
				Swivel	Total Lock Brack	Directional Lock				
100mmx24mm (4"x15/16")	Threaded Stem	50kgs (110lbs)	TPR on PP Core	1155-0402-75-2	1155-0402-75-4	1155-0402-75-9	Ball Bearing	139mm		
		50kgs (110lbs)	Resolute	1155-0402-68-2	1155-0402-68-4	1155-0402-68-9	Ball Bearing			
		50kgs (110lbs)	TPR on PP Core	1155-0402-75-2	1155-0402-75-4	1155-0402-75-9	Plain Bearing			
		50kgs (110lbs)	TPR on PP Core	1155-0402-75-2	1155-0402-75-4	1155-0402-75-9	Plain Bearing			
100mmx31mm (4"x1-1/4")		50kgs (110lbs)	TPR on PP Core	1155-0402-75-2	1155-0402-75-4	1155-0402-75-9	Ball Bearing			
		50kgs (110lbs)	Resolute	1155-0402-68-2	1155-0402-68-4	1155-0402-68-9	Ball Bearing			
		50kgs (110lbs)	TPR on PP Core	1155-0402-75-2	1155-0402-75-4	1155-0402-75-9	Plain Bearing			
		50kgs (110lbs)	TPR on PP Core	1155-0402-75-2	1155-0402-75-4	1155-0402-75-9	Plain Bearing			
100mmx24mm (4"x15/16")	Cylindrical Stem	50kgs (110lbs)	TPR on PP Core	1155-0402-75-2	1155-0402-75-4	1155-0402-75-9	Ball Bearing			
		50kgs (110lbs)	Resolute	1155-0402-68-2	1155-0402-68-4	1155-0402-68-9	Ball Bearing			
		50kgs (110lbs)	TPR on PP Core	1155-0402-75-2	1155-0402-75-4	1155-0402-75-9	Plain Bearing			
		50kgs (110lbs)	TPR on PP Core	1155-0402-75-2	1155-0402-75-4	1155-0402-75-9	Plain Bearing			
100mmx31mm (4"x1-1/4")		50kgs (110lbs)	TPR on PP Core	1155-0402-75-2	1155-0402-75-4	1155-0402-75-9	Ball Bearing			
		50kgs (110lbs)	Resolute	1155-0402-68-2	1155-0402-68-4	1155-0402-68-9	Ball Bearing			
		50kgs (110lbs)	TPR on PP Core	1155-0402-75-2	1155-0402-75-4	1155-0402-75-9	Plain Bearing			
		50kgs (110lbs)	TPR on PP Core	1155-0402-75-2	1155-0402-75-4	1155-0402-75-9	Plain Bearing			

Swivel 86mm  
Swivel W/Brake (Short pedal) 112mm  
Swivel W/Brake (Long pedal) 123mm  
Swivel W/Brake (Extra long pedal) 136mm

Swivel 36mm  
Swivel W/Total Lock Brake 46mm